

SPECTRACOOL™ SLIM FIT INDOOR

Distributed by: Mclean Parts
 5736 N. Michigan Rd
 Indianapolis, IN 46228
 317-257-6811, fax 317-257-1590
www.mcleanparts.com



S06
 1000/1700 BTU/Hr.
 300/500 Watt

S10
 3400/5000 BTU/Hr.
 1000/1500 Watt

S16
 6800/8500/13500 BTU/Hr.
 2000/2500/4000 Watt

INDUSTRY STANDARDS

UL/cUL Listed Type 12; File No.SA6453

CE
 GOST
 IP 54 Internal Loop
 IP34 External Loop

APPLICATION

- Industrial Automation
- Machine Tool
- Automotive
- Packaging handling equipment
- Material handling

FEATURES

- Slim fit design
- Standard cutout dimension for easy exchange
- Energy efficient rotary compressor
- R134a earth-friendly refrigerant
- Models for 115, 230, and 400/460 3-phase VAC power input
- UL Listed to save customers time and money with agency approvals
- Active condensate management to prevent dripping water
- Aesthetic design plastic cover to optimize air flow

- Three mounting options; fully recessed, partial recessed and surface mount
- Remote access control option for monitoring units worldwide
- Easy filter replacement for extremely dusty environments
- Dust resistant coils for filterless operation
- Every unit functionally tested before shipping
- Standard Indoor Air Conditioner models also include:
 - Door switch

SPECIFICATIONS

- Nominal cooling capacity
 - S06 1000 and 1500 BTU/hr. (300 and 500 W)
 - S10 3400 and 5000 BTU/hr. (1000 and 1500 W)
 - S16 6800, 8500, and 13500 BTU/hr. (2000, 2500, and 4000 W)
- Operating temperature range from 50 F / 10 C to 131 F / 55 C

FINISH

- RAL 7035 light-gray, semi-textured powder-coat paint

NOTES

Visit www.PentairProtect.com to download 2D and 3D CAD drawings into the overall design of your electronic system.

Performance Data **S06 1000/1700 BTU/Hr. (300/500 Watt)**

CATALOG NUMBER				
Indoor Model	S060316G050	S060326G050	S060516G050	S060526G050
Indoor Model with Remote Access Control*	S060316G060	S060326G060	S060516G060	S060526G060
COOLING PERFORMANCE				
Nominal:				
BTU/Hr.	1000	1000	1700	1700
Watts	300	300	500	500
At 95 F / 95 F (35 C / 35 C)				
BTU/Hr. (50/60 Hz)	1260/1430	1260/1430	1880/2190	1880/2190
W (50/60 Hz)	370/420	370/420	550/640	550/640
Refrigerant	R134a	R134a	R134a	R134a
Refrigerant Charge (ounces/grams)	4.7/133	4.5/128	5.7/162	5.7/162
Operating Temperature Range:				
Maximum (°F/°C)	125/52 (50 Hz) 131/55 (60 Hz)	131/55	131/55	131/55
Minimum (°F/°C)	50/10	50/10	50/10	50/10
Air Flow at 0 Static Pressure:				
Internal loop 50 Hz (CFM / m ³ /hr.)	64/109	64/109	116/197	116/197
External loop 50 Hz (CFM / m ³ /hr.)	76/129	76/129	111/189	111/189
Internal loop 60 Hz (CFM / m ³ /hr.)	73/124	73/124	137/233	137/233
External loop 60 Hz (CFM / m ³ /hr.)	92/156	92/156	129/219	129/219
ELECTRICAL DATA				
Rated Voltage	110 / 115	230	115	230
Frequency (Hz)	50/60	50/60	50/60	50/60
Operating Range	+/-10%	+/-10%	+/-10%	+/-10%
Max. Power Consumption (W)	270/300	300/320	450/470	450/480
Max. Nominal Current (A)	4.0/3.8	1.8/1.7	6.5/6.1	2.6/2.9
Starting Current (A)	13/13	6/6	21/20	9/10
Agency Approvals	UL/cUL Listed, CE, GOST			
Power Input Description	Terminal Block	Terminal Block	Terminal Block	Terminal Block
ENCLOSURE PROTECTION				
UL Type	Type 12			
International Rating	IP54 internal loop IP34 external loop			
CONTROLLER				
Description	Smart controller with display			
Thermostat Location	Ambient Side			
Factory Thermostat Setting (°F/°C)	95 / 35			
SOUND LEVEL				
At 1.5 Meters	65 dB(A)	65 dB(A)	66 dB(A)	66 dB(A)
UNIT CONSTRUCTION				
Material	Galvanized Sheet Metal Standard			
Finish	Powder Coat Semi-textured RAL 7035 Light Gray Standard			
UNIT DIMENSIONS				
Height (in./mm)	21.6 / 550			
Width (in./mm)	11.0 / 280			
Depth (in./mm)	5.5 / 140	5.5 / 140	8.1 / 206	8.1 / 206
Weight (lb./kg)	28 / 13	28 / 13	33 / 15	33 / 15

*Units with Remote Access Control utilize a digital controller and communicate via SNMP, Profinet, Ethernet, Modbus, or USB.

Performance Curves for S06 Models 1000 BTU/Hr. (300 Watt)

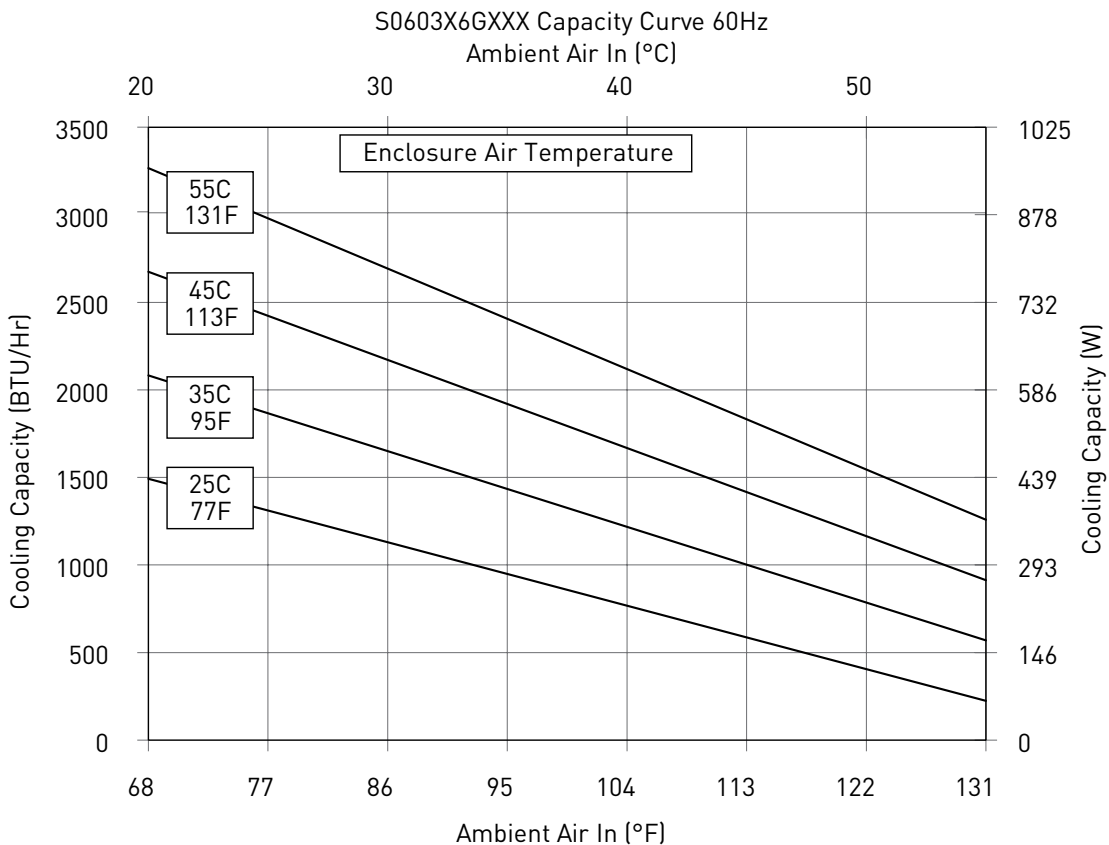
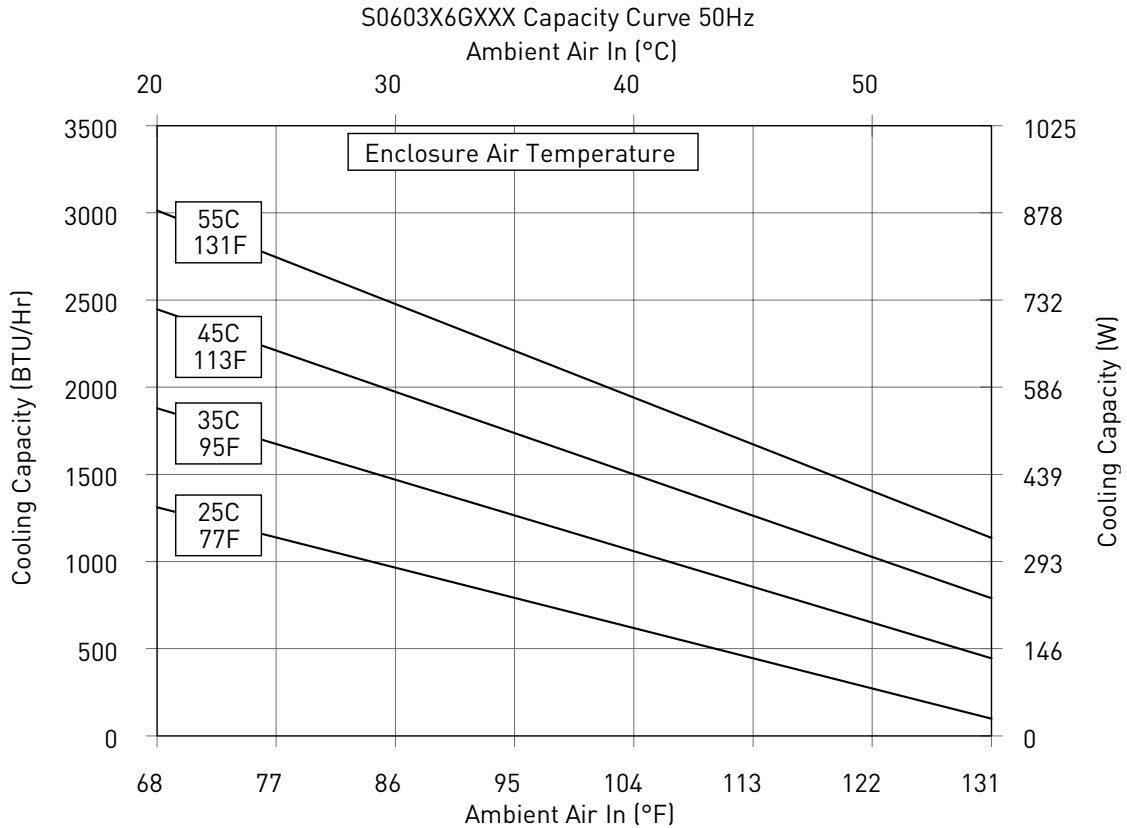

Performance Curves for S06 Models 1700 BTU/Hr. (500 Watt)

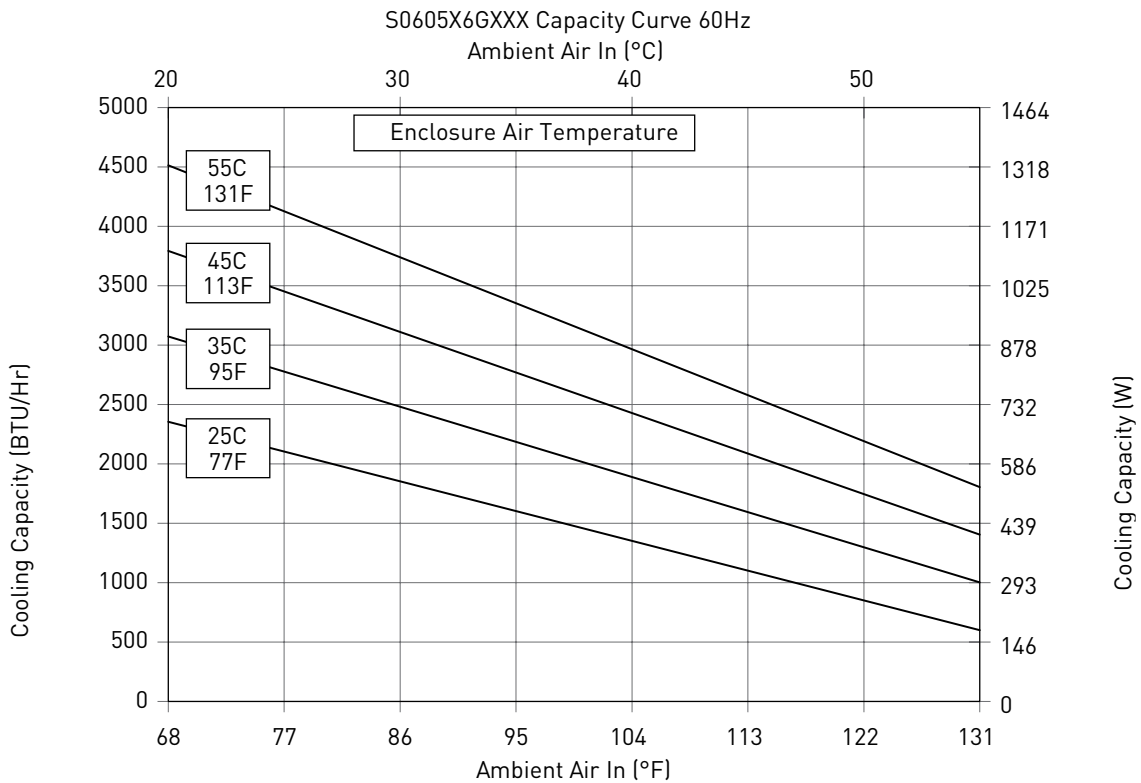
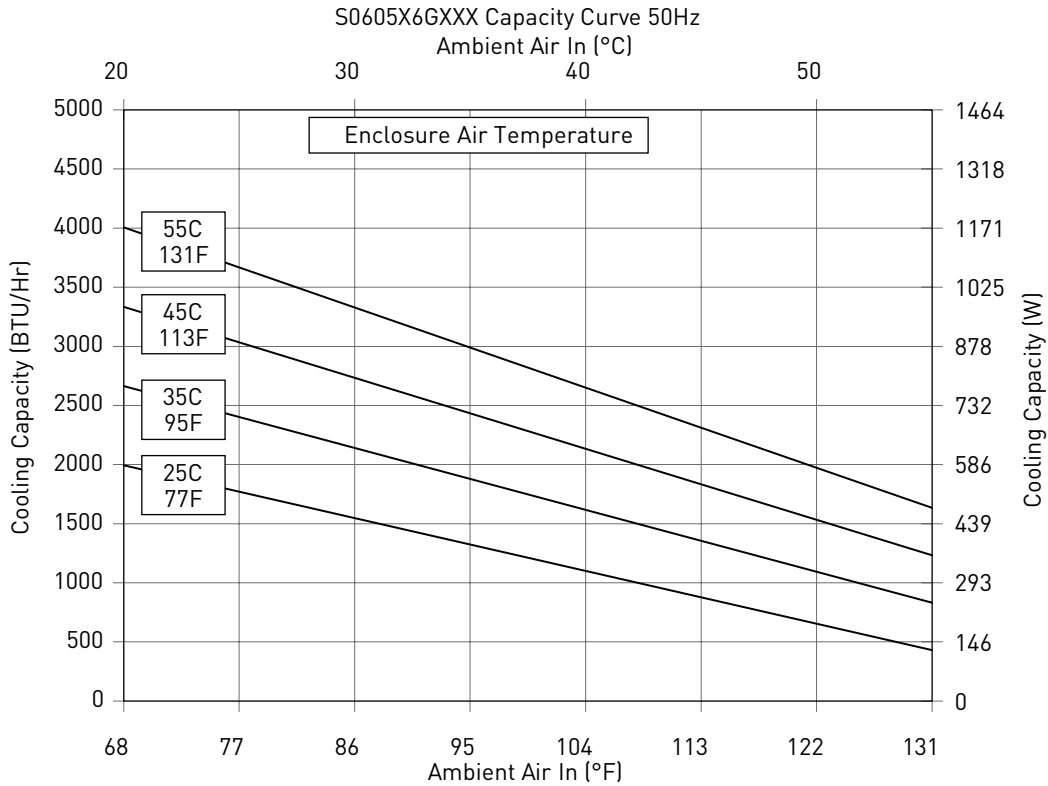

S06 Models 1000 BTU/Hr. (300 Watt)

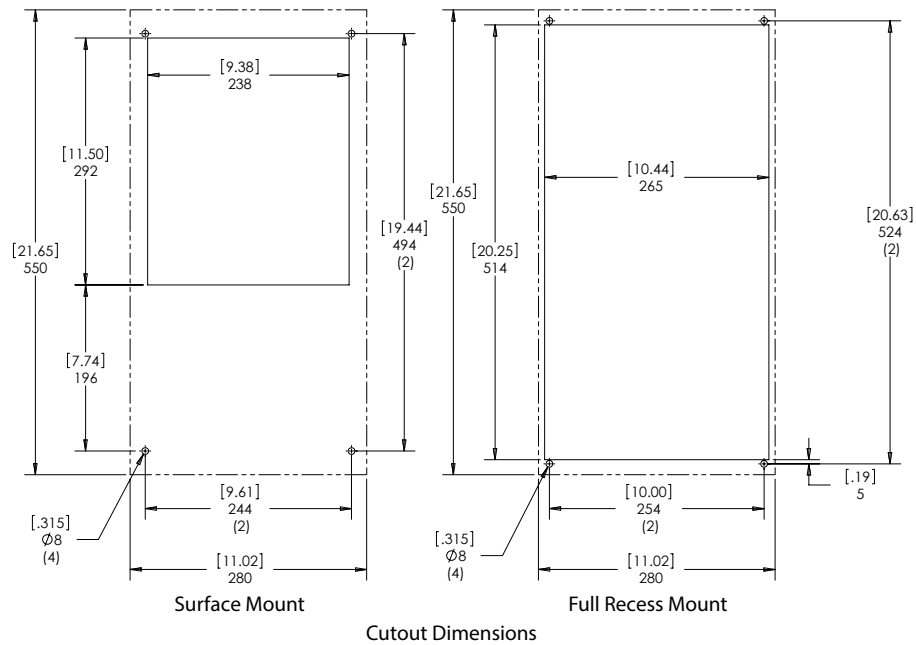
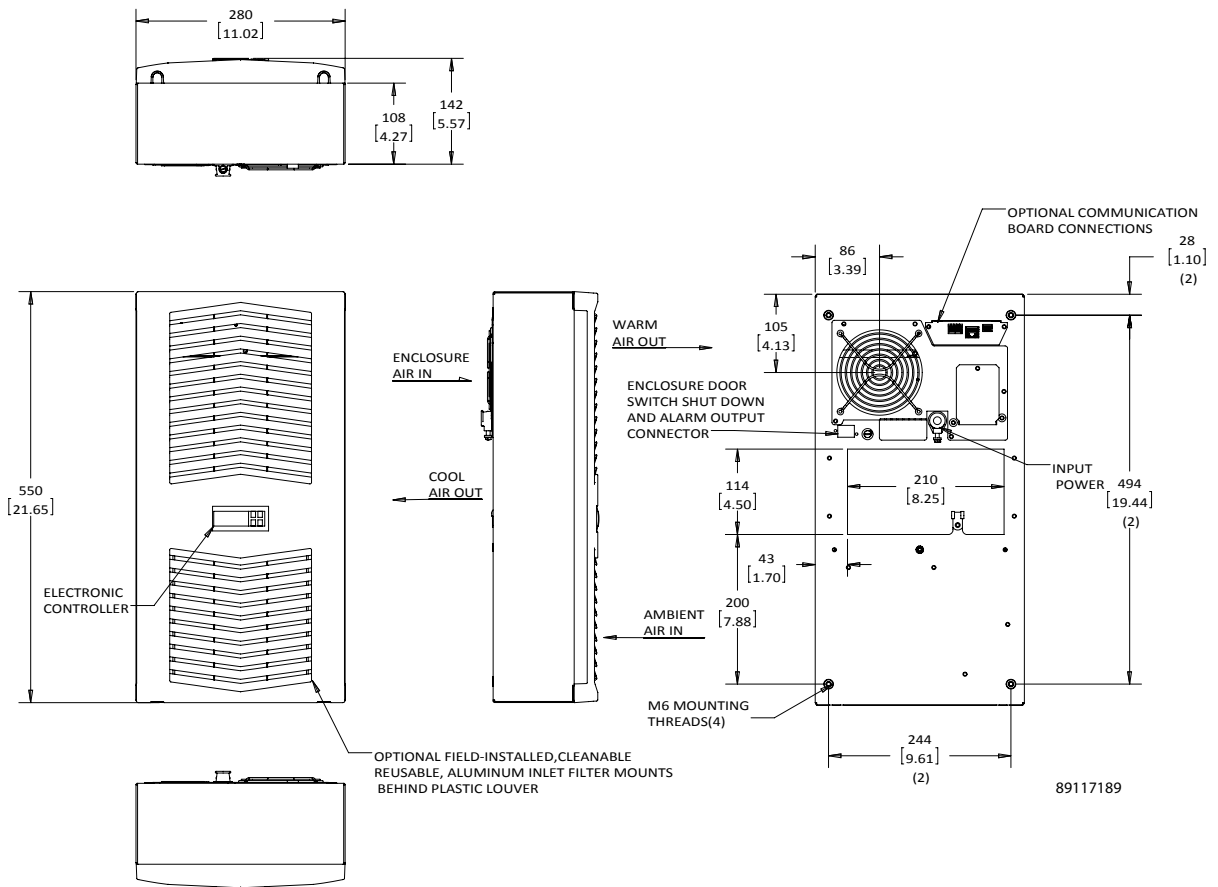

S06 Models 1700 BTU/Hr. (500 Watt)

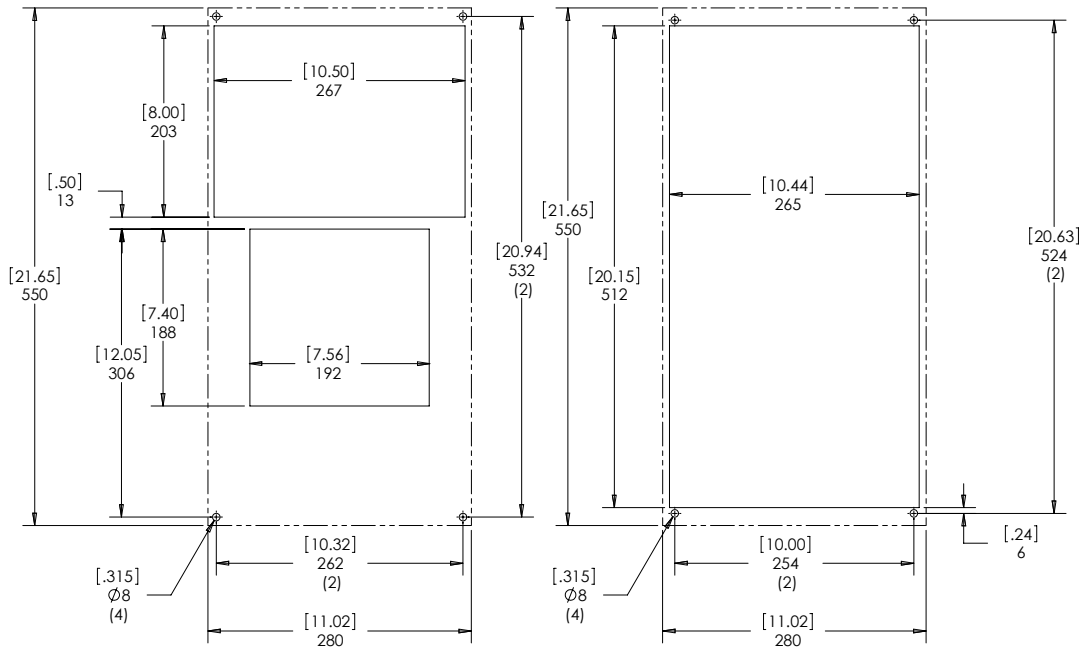
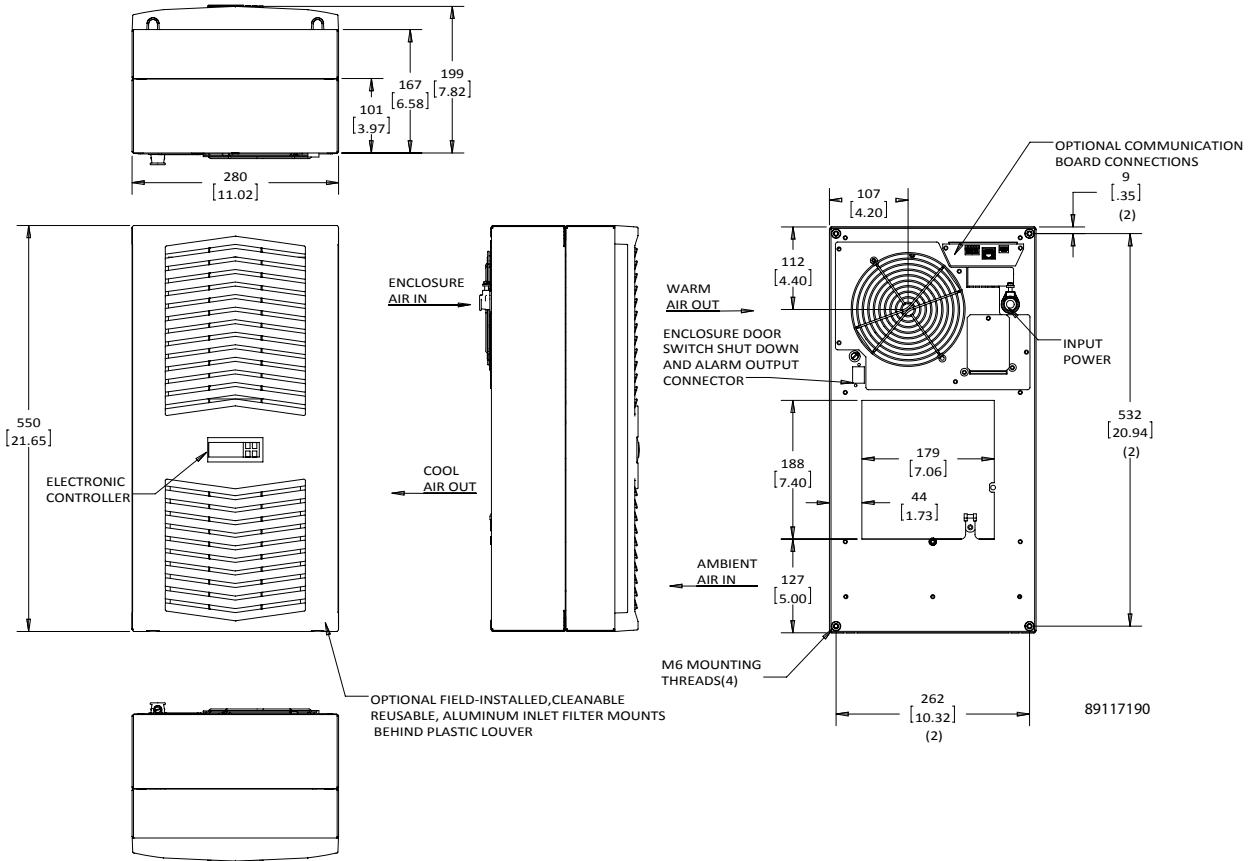

Surface Mount

Cutout Dimensions

Partial and Full Recess Mount

Performance Data S10 3400/5000 BTU/Hr. (1000/1500 Watt)

CATALOG NUMBER						
Indoor Model	S101016G050	S101026G050	S101046G050	S101516G050	S101526G050	S101546G050
Indoor Model with Remote Access Control*	S101016G060	S101026G060	S101046G060	S101516G060	S101526G060	S101546G060
COOLING PERFORMANCE						
Nominal:						
BTU/Hr.	3400	3400	3400	5000	5000	5000
Watts	1000	1000	1000	1500	1500	1500
At 95 F / 95 F [35 C / 35 C]						
BTU/Hr. (50/60 Hz)	4440/4710	4440/4710	4440/4710	6150/6420	6150/6420	6150/6420
W (50/60 Hz)	1300/1380	1300/1380	1300/1380	1800/1880	1800/1880	1800/1880
Refrigerant	R134a	R134a	R134a	R134a	R134a	R134a
Refrigerant Charge (ounces/grams)	10/283	10/283	10/283	15/425	15/425	18/510
Operating Temperature Range:						
Maximum (°F/°C)	131/55	131/55	131/55	131/55	131/55	131/55
Minimum (°F/°C)	50/10	50/10	50/10	50/10	50/10	50/10
Air Flow at 0 Static Pressure:						
Internal loop 50 Hz (CFM / m ³ /hr.)	206/350	206/350	206/350	201/342	201/342	201/342
External loop 50 Hz (CFM / m ³ /hr.)	334/567	334/567	334/567	339/576	339/576	339/576
Internal loop 60 Hz (CFM / m ³ /hr.)	230/391	230/391	230/391	230/391	230/391	230/391
External loop 60 Hz (CFM / m ³ /hr.)	344/584	344/584	344/584	341/579	341/579	341/579
ELECTRICAL DATA						
Rated Voltage	115	230	400 / 460 1~	115	230	400 / 460 3~
Frequency (Hz)	50/60	50/60	50/60	50/60	50/60	50/60
Operating Range	+/-10%	+/-10%	+/-10%	+/-10%	+/-10%	+/-10%
Max. Power Consumption (W)	810/1010	670/800	750/960	850/1040	850/1040	930/1130
Max. Nominal Current (A)	9.6/10.2	4.1/5.5	2.1/2.4	9.6/10.2	5.1/6.7	2.1/2.4
Starting Current (A)	32/34	14/18	7/8	32/34	17/22	7/8
Agency Approvals	UL/cUL Listed, CE, GOST					
Power Input Description	Terminal Block	Terminal Block	Terminal Block	Terminal Block	Terminal Block	Terminal Block
ENCLOSURE PROTECTION						
UL Type	Type 12					
International Rating	IP54 internal loop IP34 external loop					
CONTROLLER						
Description	Smart controller with display					
Thermostat Location	Ambient Side					
Factory Thermostat Setting (°F/°C)	95 / 35					
SOUND LEVEL						
At 1.5 Meters	69 dB(A)	69 dB(A)	69 dB(A)	70dB(A)	70dB(A)	70dB(A)
UNIT CONSTRUCTION						
Material	Galvanized Sheet Metal Standard					
Finish	Powder Coat Semi-textured RAL 7035 Light Gray Standard					
UNIT DIMENSIONS						
Height (in./mm)	37.4 / 950					
Width (in./mm)	15.7 / 400					
Depth (in./mm)	10.2 / 259					
Weight (lb./kg)	86/39	86/39	99/45	95/43	95/43	95/43

*Units with Remote Access Control utilize a digital controller and communicate via SNMP, Profinet, Ethernet, Modbus, or USB.

Performance Curves for S10 Models 3400 BTU/Hr. (1000 Watt)

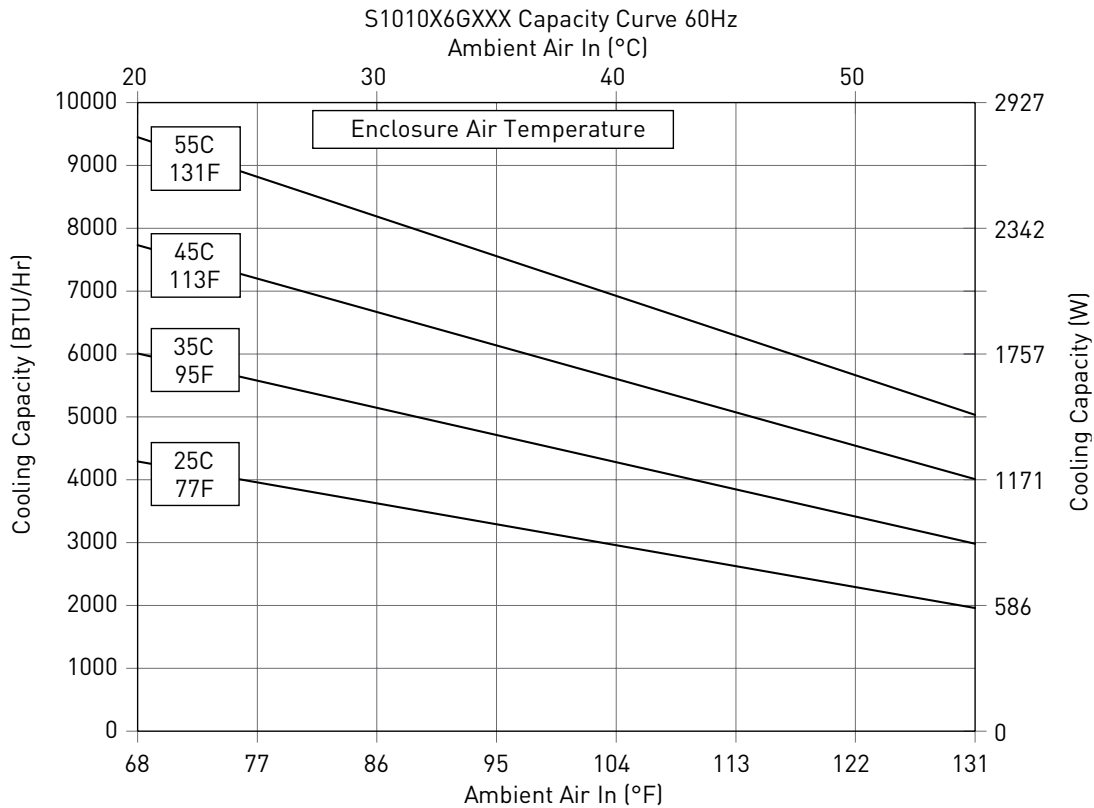
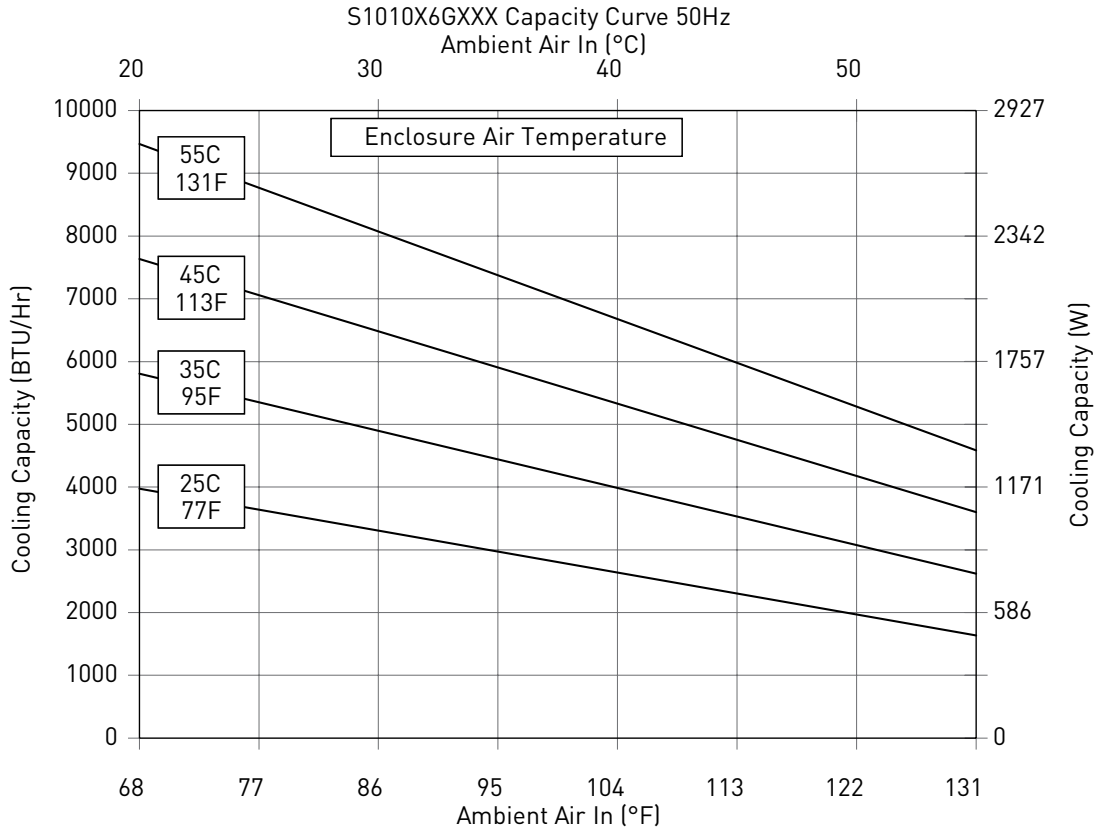

Performance Curves for S10 Models 5000 BTU/Hr. (1500 Watt)

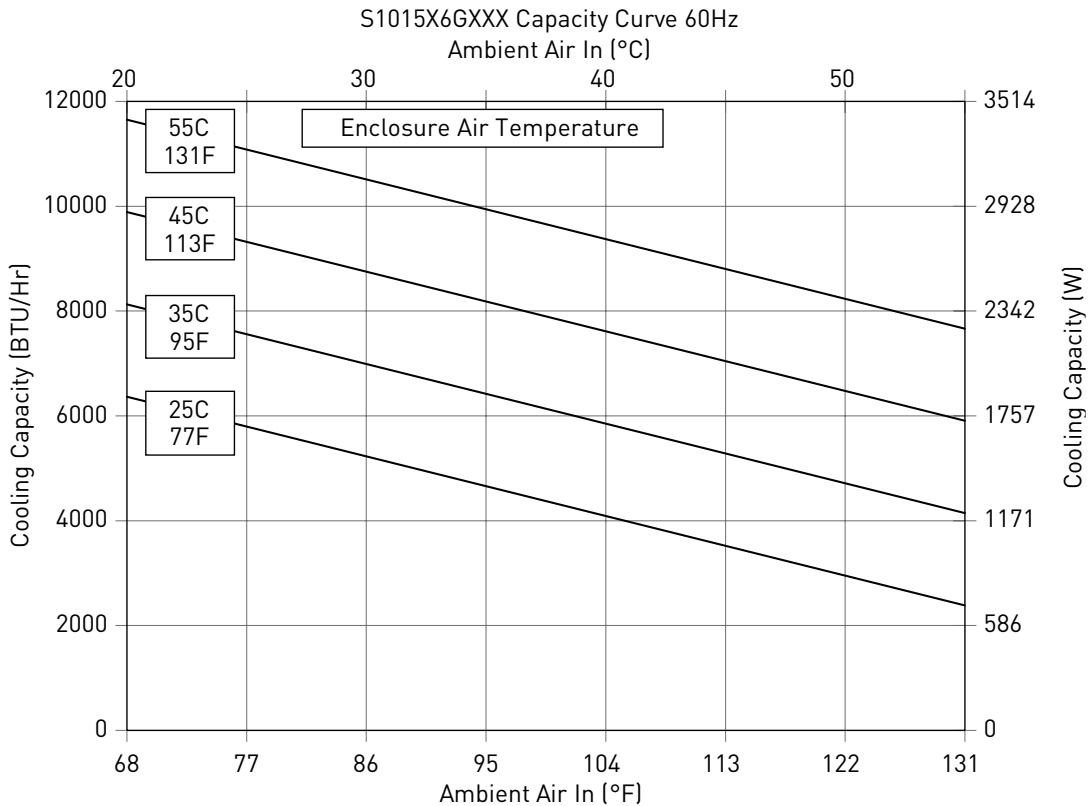
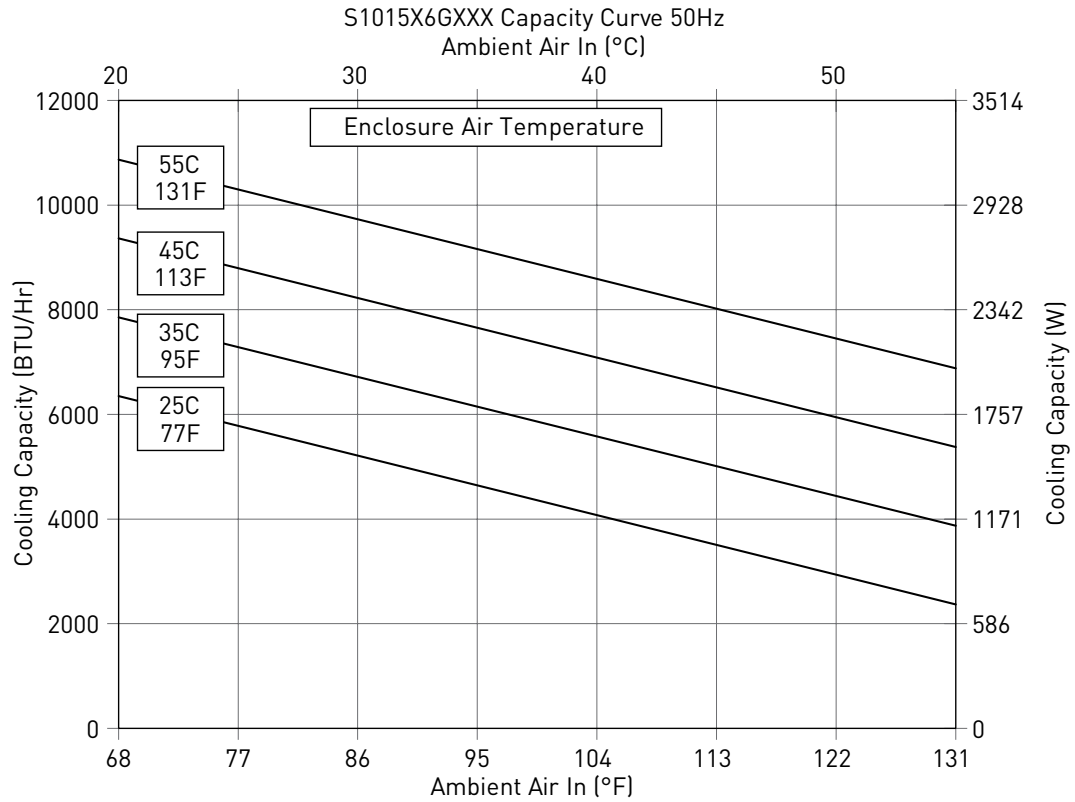

S10 Models 3400/5000 BTU/Hr. (1000/1500 Watt)

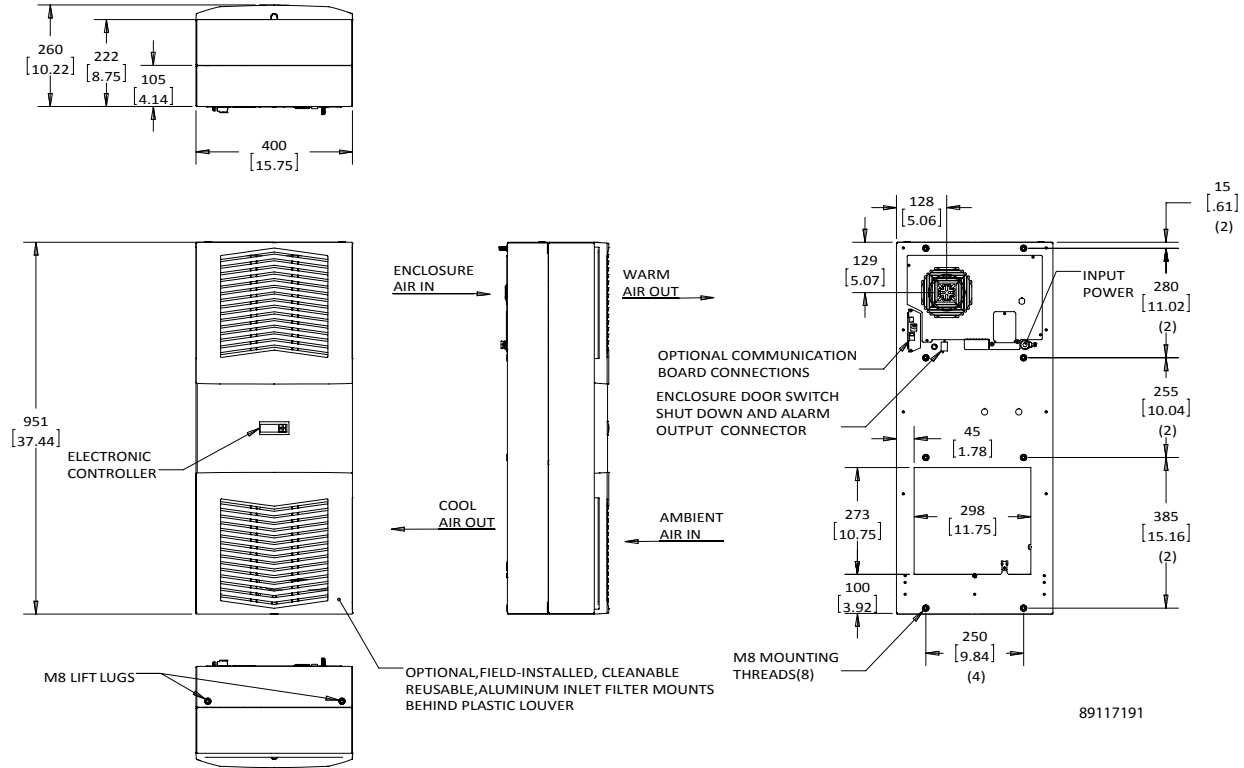

89117191

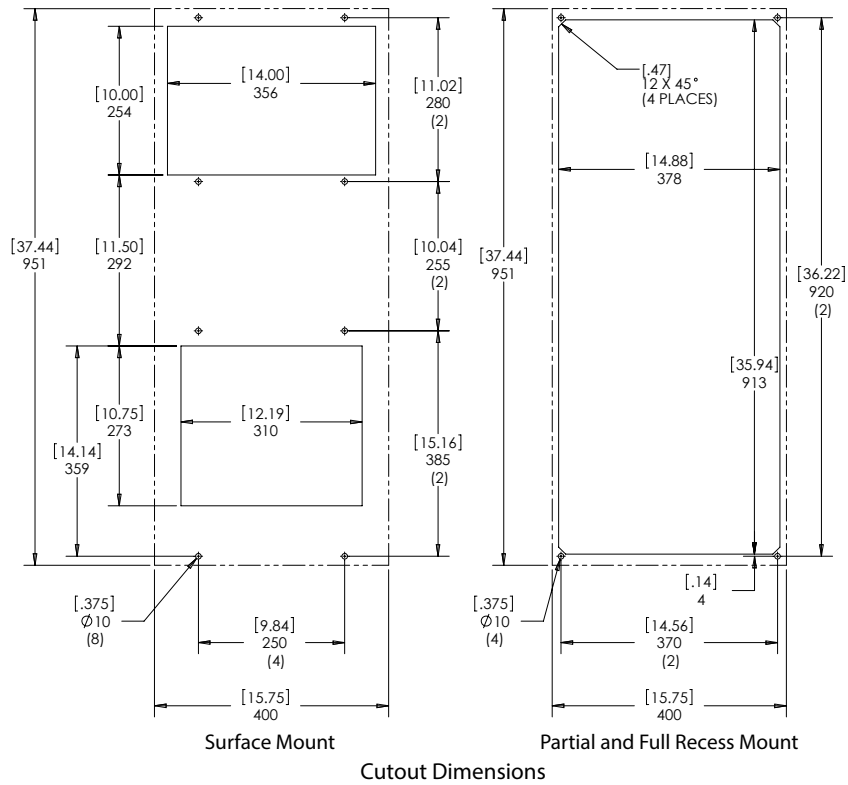

Performance Data S16 6800/8500/13500 BTU/Hr. (2000/2500/4000 Watt)

CATALOG NUMBER							
Indoor Model	S162016G050	S162026G050	S162046G050	S162516G050	S162526G050	S162546G050	S164046G050
Indoor Model with Remote Access Control*	S162016G060	S162026G060	S162046G060	S162516G060	S162526G060	S162546G060	S164046G060
COOLING PERFORMANCE							
Nominal:							
BTU/Hr.	6800	6800	6800	8500	8500	8500	13500
Watts	2000	2000	2000	2500	2500	2500	4000
At 95 F / 95 F (35 C / 35 C)							
BTU/Hr. (50/60 Hz)	7510/8200	7510/8200	7510/8200	9150/9560	9150/9560	9150/9560	13700/15400
W (50/60 Hz)	2200/2400	2200/2400	2200/2400	2680/2800	2680/2800	2680/2800	4000/4500
Refrigerant	R134a	R134a	R134a	R134a	R134a	R134a	R134a
Refrigerant Charge (ounces/grams)	25/709	25/709	25/709	26/737	26/737	30/850	44/1247
Operating Temperature Range:							
Maximum (°F/°C)	131/55	131/55	131/55	131/55	131/55	131/55	131/55
Minimum (°F/°C)	50/10	50/10	50/10	50/10	50/10	50/10	50/10
Air Flow at 0 Static Pressure:							
Internal loop 50 Hz (CFM / m ³ /hr.)	267/454	267/454	267/454	263/447	263/447	263/447	291/494
External loop 50 Hz (CFM / m ³ /hr.)	373/634	373/634	373/634	650/1104	650/1104	650/1104	630/1070
Internal loop 60 Hz (CFM / m ³ /hr.)	285/484	285/484	285/484	274/466	274/466	274/466	339/576
External loop 60 Hz (CFM / m ³ /hr.)	385/654	385/654	385/654	673/1143	673/1143	673/1143	697/1184
ELECTRICAL DATA							
Rated Voltage	115	230	400 / 460 3~	115	230	400 / 460 3~	400 / 460 3~
Frequency (Hz)	50/60	50/60	50/60	50/60	50/60	50/60	50/60
Operating Range	+/-10%	+/-10%	+/-10%	+/-10%	+/-10%	+/-10%	+/-10%
Max. Power Consumption (W)	930/1090	940/1140	900/1180	1230/1420	1320/1650	1150/1510	1790/2310
Max. Nominal Current (A)	11.1/12.5	5.7/7.2	2.2/2.6	16.1/16.9	8.0/10.1	3.2/3.4	4.2/4.4
Starting Current (A)	37/41	19/24	7/9	53/56	26/33	11/11	14/15
Agency Approvals	UL/cUL Listed, CE, GOST						
Power Input Description	Terminal Block	Terminal Block	Terminal Block	Terminal Block	Terminal Block	Terminal Block	Terminal Block
ENCLOSURE PROTECTION							
UL Type	Type 12						
International Rating	IP54 internal loop IP34 external loop						
CONTROLLER							
Description	Smart controller with display						
Thermostat Location	Ambient Side						
Factory Thermostat Setting (°F/°C)	95 / 35						
SOUND LEVEL							
At 1.5 Meters	67 dB(A)	67 dB(A)	67 dB(A)	71 dB(A)	71 dB(A)	71 dB(A)	70 dB(A)
UNIT CONSTRUCTION							
Material	Galvanized Sheet Metal Standard						
Finish	Powder Coat Semi-textured RAL 7035 Light Gray Standard						
UNIT DIMENSIONS							
Height (in./mm)	62.2/1580						
Width (in./mm)	15.7/400	15.7/400	15.7/400	15.7/400	15.7/400	15.7/400	19.7/500
Depth (in./mm)	11.6/295	11.6/295	11.6/295	11.6/295	11.6/295	11.6/295	13.4/340
Weight (lb./kg)	150/68	150/68	150/68	154/70	154/70	154/70	203/92

*Units with Remote Access Control utilize a digital controller and communicate via SNMP, Profinet, Ethernet, Modbus, or USB.

Performance Curves for S16 Models 6800 BTU/Hr. (2000 Watt)

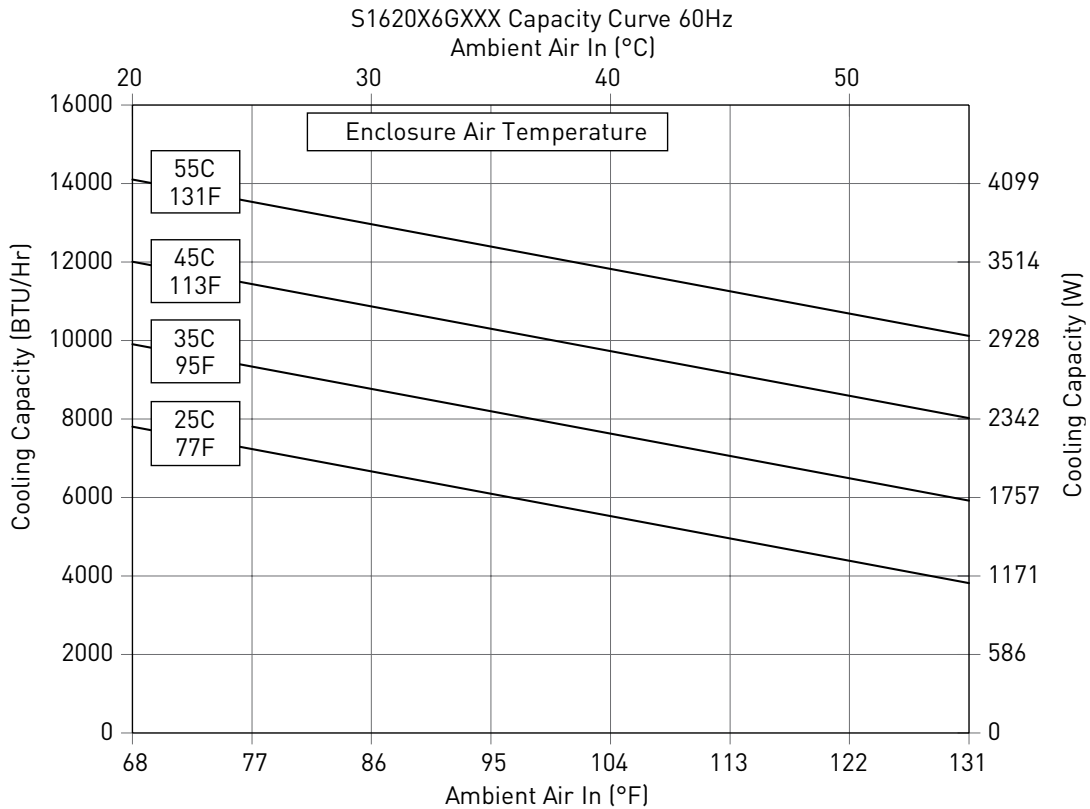
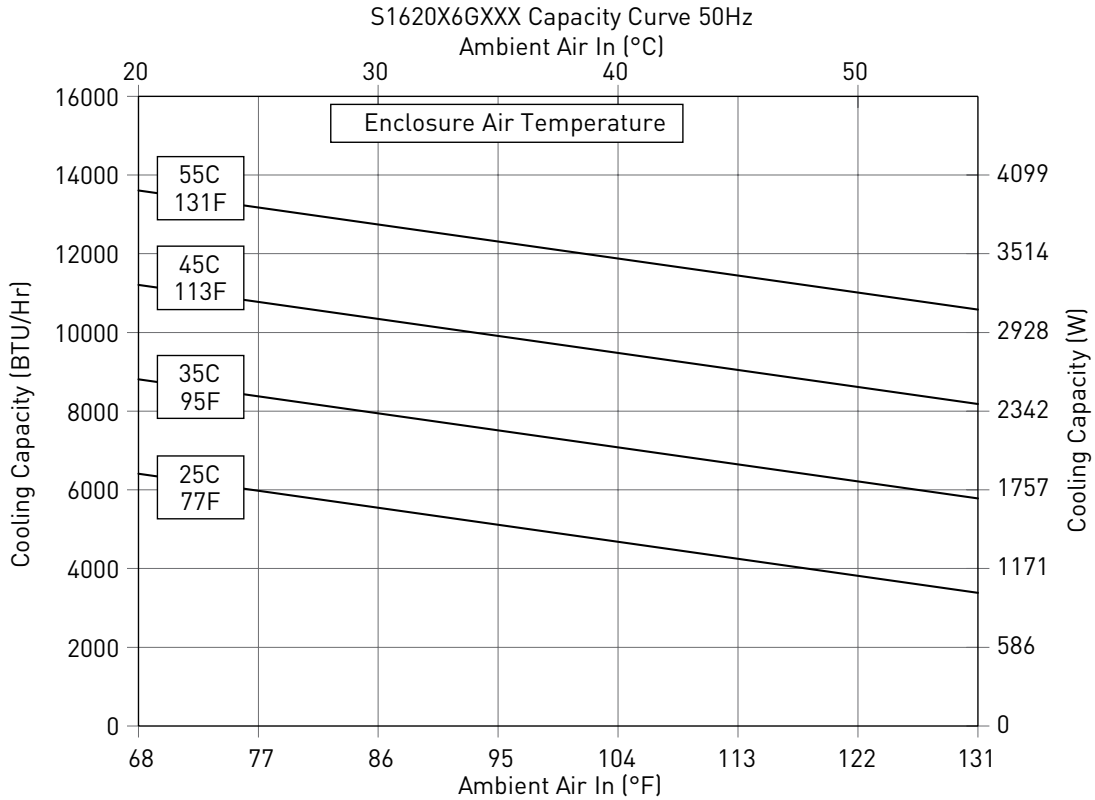

Performance Curves for S16 Models 8500 BTU/Hr. (2500 Watt)

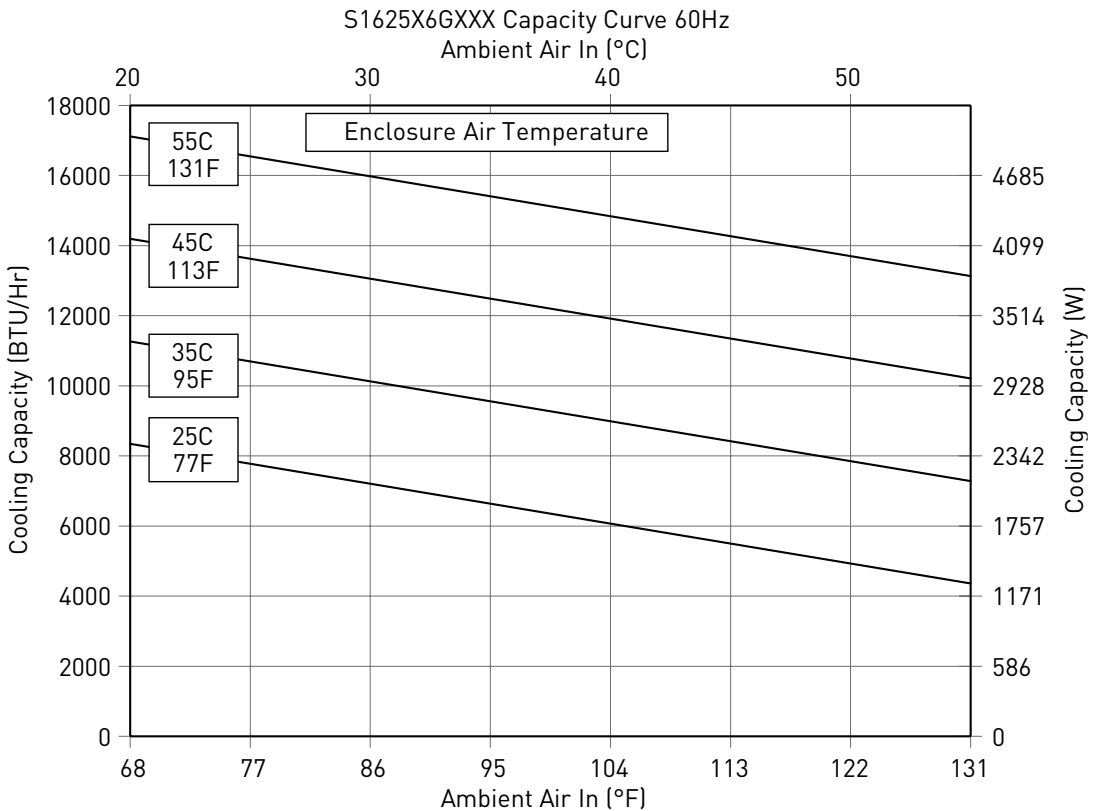
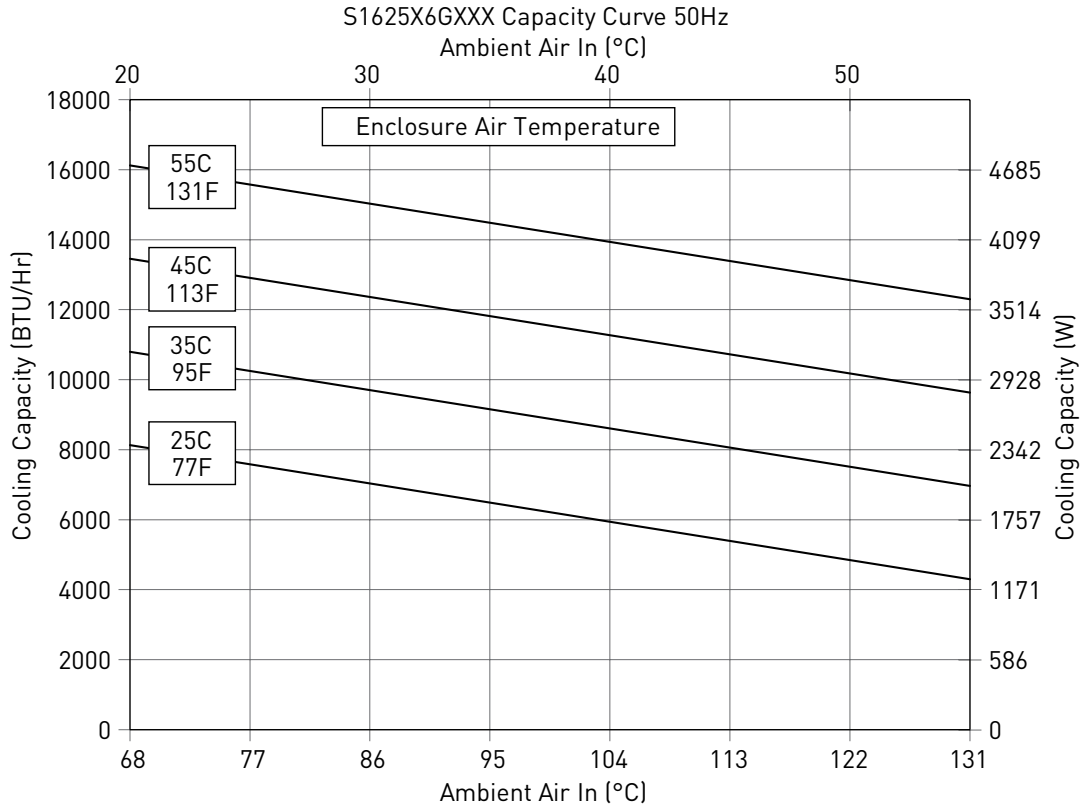

Performance Curves for S16 Models 13500 BTU/Hr. (4000 Watt)

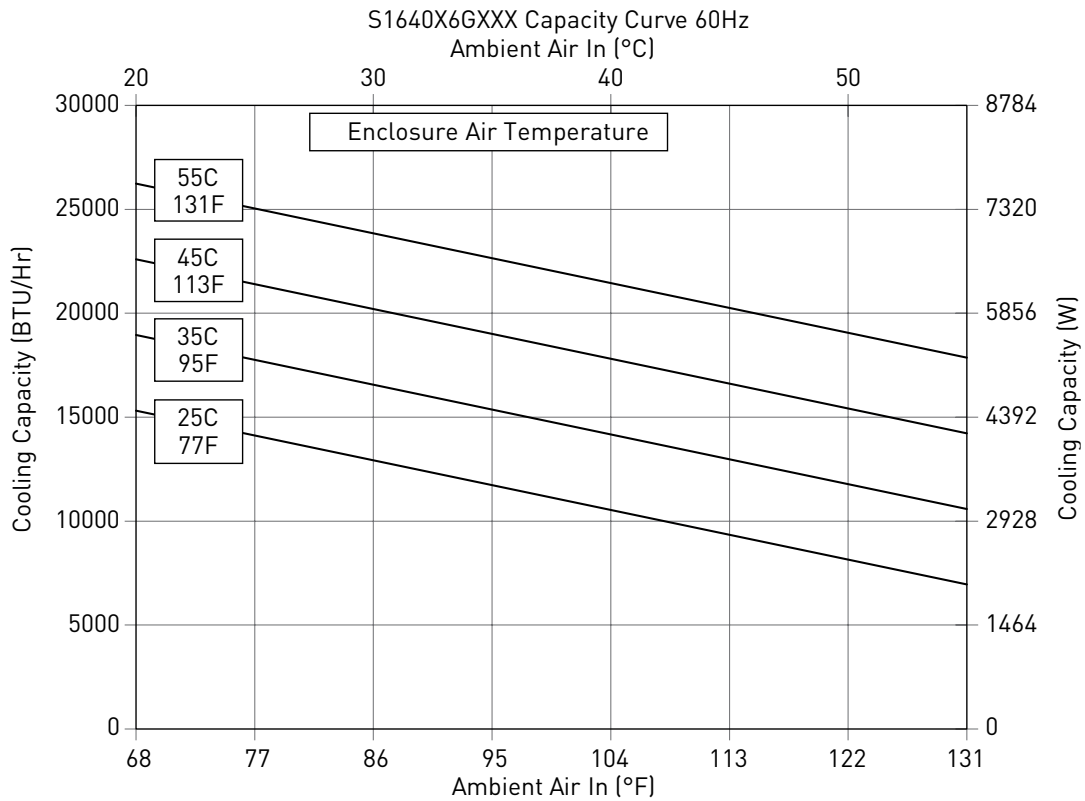
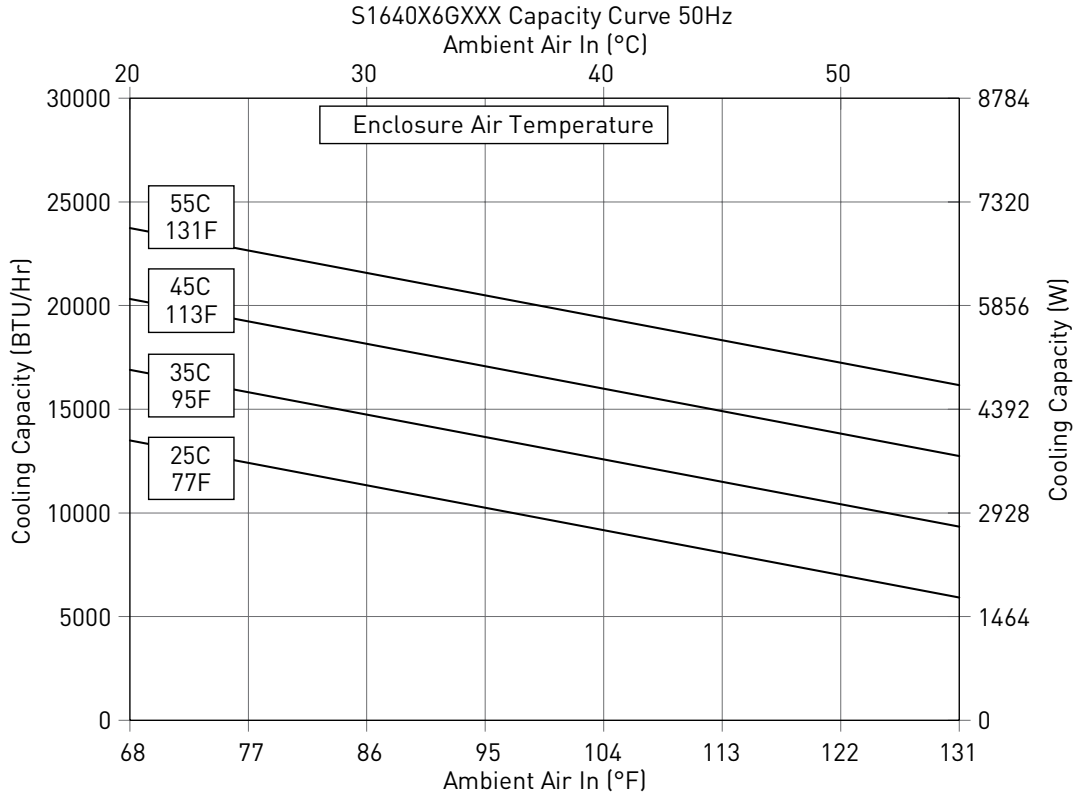

S16 Models 6800/8500 BTU/Hr. (2000/2500 Watt)

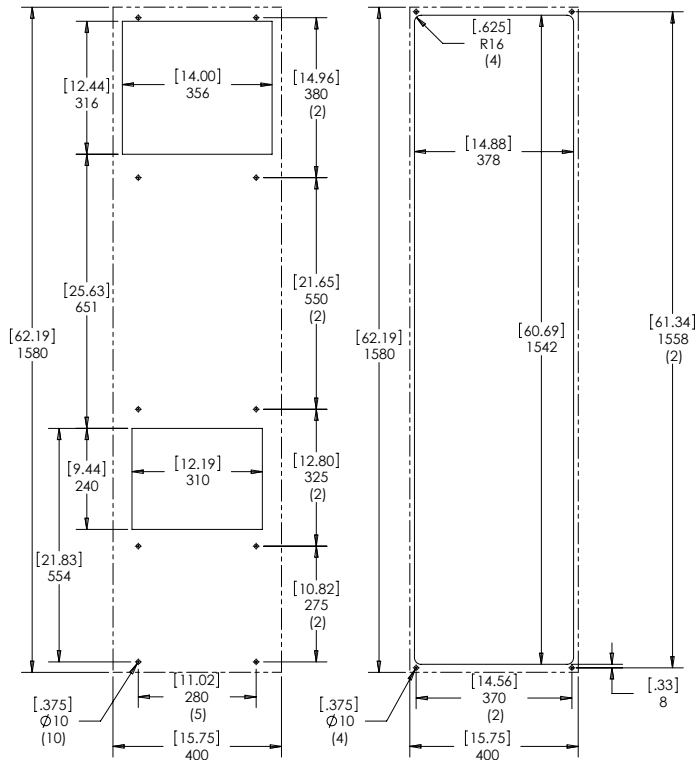
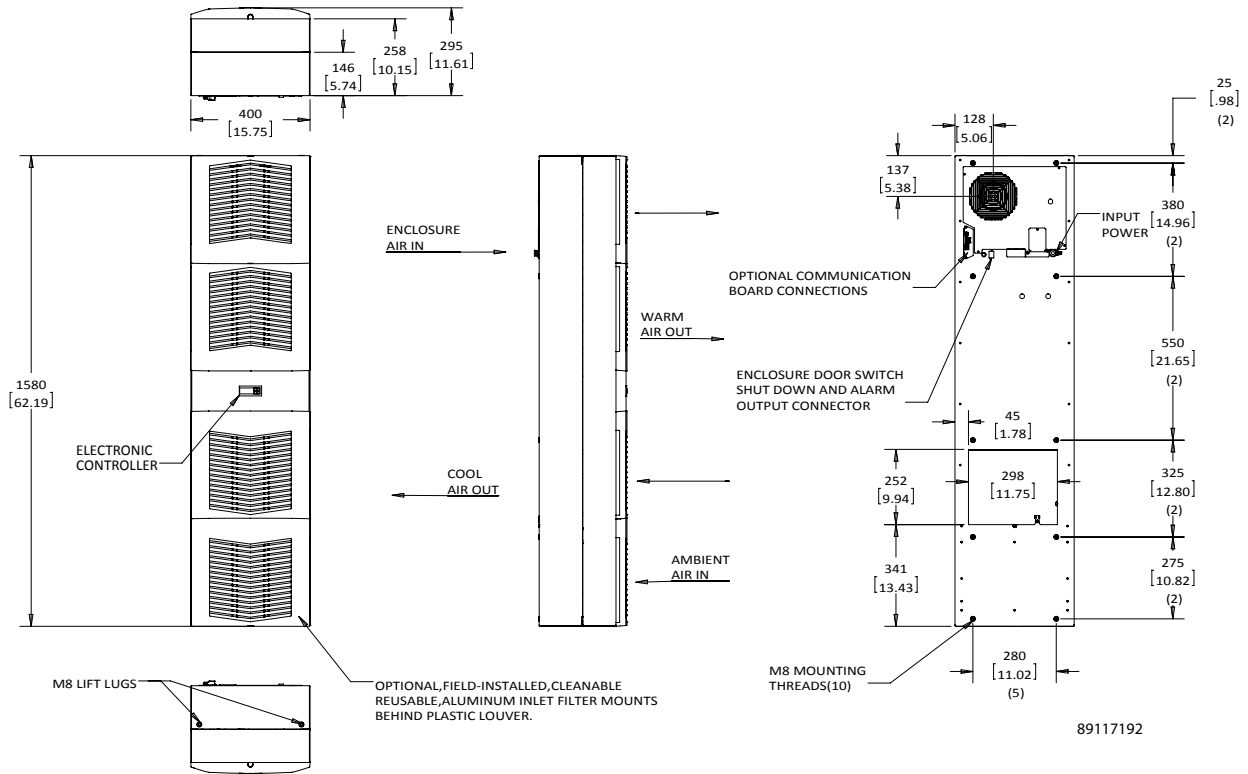

Cutout Dimensions

S16 Models 13500 BTU/Hr. (4000 Watt)

